

~~AUMENTO PREZZI~~
~~+10%~~

ACF NIGHT

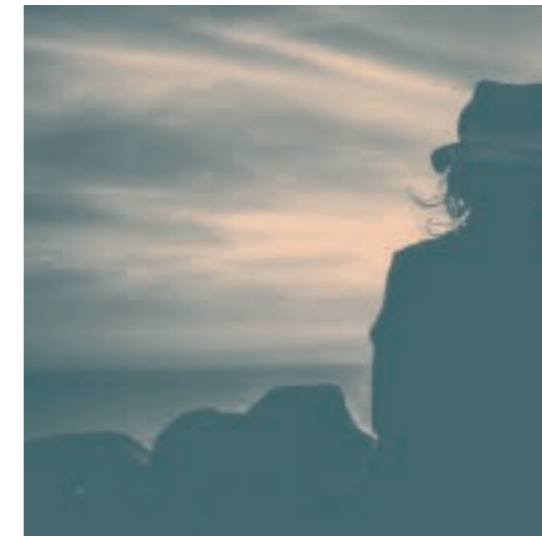

collection 2018

letti / gruppi / armadi
beds / suites / wardrobes

CREATIVE NIGHT

collection

content

letti - gruppi - armadi
beds - suites - wardrobes

- # 1 **Sky + Way + Door**
page 05
- # 2 **Viki + Gliss + Basic**
page 15
- # 3 **Smile + Gliss + Arco**
page 25
- # 4 **Maya + Beta + Gola**
page 35
- # 5 **Dory + Way + Basic**
page 45
- # 6 **Qubo + Beta + Basic**
page 55
- # 7 **Spark + Way + Gola**
page 63
- Technical details**
page 71
- Price list**
page 81

5 AV



#1

CITY

inspiration mood

LA CITTÀ MODERNA ISPIRA
AMBIENTI IN EQUILIBRIO TRA
STILE E PRATICITÀ. LA FORMA
È IMPORTANTE, MA DEVE
SEMPRE ANDARE DI PARI PASSO
CON LA SOSTANZA.



Modern life inspires
settings poised between
style and practicality.
Shape is important but
needs to go hand-in-
hand with substance.

SKY

letto _ bed

WAY

gruppo _ suite

DOOR

armadio _ wardrobe

↳ Letto **SKY** in melaminico olmo Artico con cuscini in ecopelle Bianco
 Gruppo **WAY** in melaminico olmo Artico
 Armadio battente **DOOR** in melaminico Ghiaccio

SKY bed: Artico melamine elm with Bianco eco-leather pillows
WAY suite: Artico melamine elm
DOOR hinged wardrobe: Ghiaccio melamine



Le venature
 dell'olmo rivestono
 tutti gli arredi
 della camera.
 Nel letto,
 si possono
 aggiungere
 due cuscini per
 rendere più
 morbida la notte.

The elm grain
 characterises all the
 furnishings in the
 room. You can add
 two pillows to the bed
 to make it even softer.

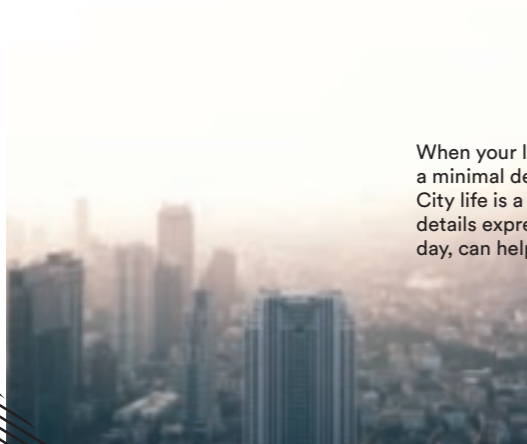

When your life is hectic, you want a setting with a minimal design and comfortable solutions. City life is a mix of linear shapes and super comfortable details expressed in furnishings that, at the end of the day, can help you relax your body and mind.

inspiration mood **City life style**

Quando i ritmi sono frenetici, si ricerca per i propri spazi un design minimal da integrare con soluzioni comode. La vita di città è un mix di forme lineari e dettagli super confortevoli, declinati in arredi che a fine giornata devono saper accogliere senza appesantire corpo e mente.



Sky + Way + Door



LETTO IN LEGNO SKY

Sky + Way + Door



CON LA SUA ESSENZIALITÀ,
L'ARMADIO COMPLETA LO STILE
DELLA CAMERA MODERNA.

THE WARDROBE COMPLETES THIS
MODERN BEDROOM WITH ITS
ESSENTIAL DESIGN.



night collection

inspiration mood

→ Armadio battente **DOOR** in melaminico Ghiaccio
DOOR hinged wardrobe: Ghiaccio melamine

LETTO, GRUPPO E ARMADIO CONDIVIDONO
LA STESSA FINITURA E LA LINEARITÀ.
UNA COMPOSIZIONE PER CHI CERCA UNA
CAMERA SEMPLICE MA DI TENDENZA.

THE BED, SUITE, AND WARDROBE SHARE
THE SAME FINISHES AND LINEAR DESIGN.
A COMPOSITION FOR THOSE WHO WANT
A SIMPLE YET TRENDY BEDROOM.

WAY

melaminico olmo Artico / Artico melamine elm
comodino / bedside table L 385 x H 478 x P 443 mm - L 570 x H 368 x P 443 mm
comò / dresser L 1220 x H 769 x P 544 mm

gruppo _ suite



DOOR

battente melaminico olmo Artico / Artico melamine elm hinged wardrobe
L 2714 x H 2550 x P 622 mm

armadio _ wardrobe



letto _ bed

SKY

melaminico olmo Artico + cuscini in ecopelle Bianco /
Artico melamine elm + Bianco eco-leather pillows
L 1690 x H 1020 x P 2060 mm

LE LINEE SI CURVANO,
 I MOVIMENTI DIVENTANO
 MORBIDI E L'ATMOSFERA
 SI FA LEGGERA: LA NOTTE TI
 CULLA DELICATAMENTE TRA
 LE SUE ONDE.



2

OCEAN
inspiration mood



SURF



Curvier lines, softer
 movements, and a more
 ethereal atmosphere.
 Night-time rocks you
 gently among its waves.

VIKI
 letto _ bed

GLISS
 gruppo _ suite

BASIC
 armadio _ wardrobe

↳ Letto **VIKI** in melaminico olmo Artico
 Gruppo **GLISS** in melaminico Ghiaccio
 Armadio scorrevole **BASIC** in melaminico olmo Artico

VIKI bed: Artico melamine elm
GLISS suite: Ghiaccio melamine
BASIC sliding wardrobe: Artico melamine elm

Superfici in
 essenza e lisce
 dalle tonalità
 chiare danno
 forma a una
 camera da letto
 luminosa, che
 ispira serenità.

Smooth surfaces with
 wood finishes and
 light shades create
 a luminous bedroom
 that inspires serenity.

Viki + Gliss + Basic

Viki + Gliss + Basic



LETTO IN LEGNO VIKI



UN'ONDA LEGGERMENTE
INCLINATA ALL'INDIETRO DÀ DINAMISMO
AL DESIGN DELLA TESTIERA.

A WAVE, SLIGHTLY BENT BACKWARDS,
MAKES THE DESIGN
OF THE HEADBOARD MORE DYNAMIC.

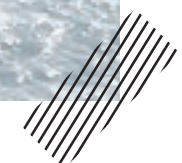

freedom
 inspiration mood

L'armadio offre la piena libertà di contenere tutto il necessario. Coordinato al letto, le sue venature scaldano e portano naturalezza in camera da letto.

The wardrobe can store everything you need. Its grain matches the bed, adding a warm and natural touch to the bedroom.



➔ Armadio scorrevole **BASIC** in melaminico olmo Artico
BASIC sliding wardrobe: Artico melamine elm

I FRONTALI ARROTONDATI DEL GRUPPO
E LA TESTIERA CURVATA DEL LETTO SI ABBINANO
ALLA RIGOROSA GEOMETRIA DELL'ARMADIO.
PER CHI RICERCA UNA CAMERA DINAMICA.

THE ROUNDED FRONTS OF THE SUITE AND
THE CURVED HEADBOARD ON THE BED MATCH
THE RIGOROUS GEOMETRY OF THE WARDROBE.
FOR THOSE WHO WANT A DYNAMIC BEDROOM.

GLISS

melaminico olmo Artico / Artico melamine elm
comodino / bedside table L 504 x H 451 x P 447 mm
comò / dresser L 1290 x H 739 x P 563 mm

gruppo _ suite



BASIC

scorrevole melaminico olmo Artico / Artico melamine elm sliding wardrobe
L 2714 x H 2550 x P 674 mm

armadio _ wardrobe



letto _ bed

VIKI

melaminico olmo Artico / Artico melamine elm
L 1680 x H 925 x P 2153 mm

Rounded hilltops and sweet slopes inspire a soft and sinuous bedroom that expresses harmony through its elements.

NATURE



CIME ARROTONDATE E DOLCI PENDII ISPIRANO UNA NOTTE MORBIDA E FLESSUOSA, CHE ATTRAVERSO I SUOI ELEMENTI ESPRIME UNA GRANDE ARMONIA.

3

HILL
inspiration mood

SMILE

letto _ bed

GLISS

gruppo _ suite

ARCO

armadio _ wardrobe



↳ Letto **SMILE** in ecopelle Bianco
 Gruppo **GLISS** in melaminico Ghiaccio
 Armadio scorrevole **ARCO** in melaminico Ghiaccio

Bianco eco-leather **SMILE** bed
GLISS suite: Ghiaccio melamine
ARCO sliding wardrobe: Ghiaccio melamine

Le superfici
 lisce del gruppo,
 l'ecopelle del
 letto e gli inserti
 a specchio
 dell'armadio:
 la combinazione
 di finiture esalta la
 varietà espressiva
 della notte.

The combination of
 smooth surfaces for
 the suite, eco-leather
 on the bed and
 mirror inserts on the
 wardrobe enhance the
 expressive variety of
 the night-time space.





LETTO IMBOTTITO SMILE

A slow lifestyle means taking your time, even when it comes to sleeping. Its soft shapes are an invitation to rest and relax. Its curved lines characterise the headboard and the fronts of the suite. The upholstered bed is a world of softness.



Slow life style

Vivere una vita "lenta" significa prendersi il proprio tempo, anche quando si tratta di dormire. Con le sue forme soft, il design concilia il riposo e invita al relax: le linee curve caratterizzano i frontali del gruppo e la testiera. Il letto imbottito è un microcosmo di morbidezza.



A new space opens beyond the curve.
The mirror inserts on the wardrobe doors almost double the space. This is the ideal solution for those who have a small bedroom but don't want to live without a practical wardrobe.



h a r m o n y

inspiration mood

Oltre la curva, si apre un nuovo spazio: gli inserti a specchio sulle ante dilatano e amplificano l'ambiente, sembrano quasi raddoppiarlo. Dal punto di vista decorativo, questa è la soluzione ideale per chi ha una camera di piccole dimensioni, ma non vuole rinunciare alla praticità dell'armadio.



→ Armadio scorrevole **ARCO** in melaminico Ghiaccio
ARCO sliding wardrobe: Ghiaccio melamine

LINEE ARROTONDATE PER GRUPPO,
LETTO E ARMADIO: IL DESIGN DELLA LINEA
CURVA CONQUISTA CHI AMA CAMERE
ROMANTICHE E RICERCATE.

THE SUITE, BED, AND WARDROBE
FEATURE ROUNDED LINES,
PERFECT FOR THOSE WHO WANT A ROMANTIC
AND SOPHISTICATED BEDROOM.

GLISS

melaminico olmo Artico / Artico melamine elm
comodino / bedside table L 504 x H 451 x P 447 mm
comò / dresser L 1290 x H 739 x P 563 mm

gruppo _ suite



ARCO

scorrevole melaminico olmo Artico / Artico melamine elm sliding wardrobe
L 2714 x H 2550 x P 674 mm

armadio _ wardrobe



letto _ bed

SMILE

ecopelle Bianco / Bianco eco-leather
L 1750 x H 1050 x P 2120 mm

ICE

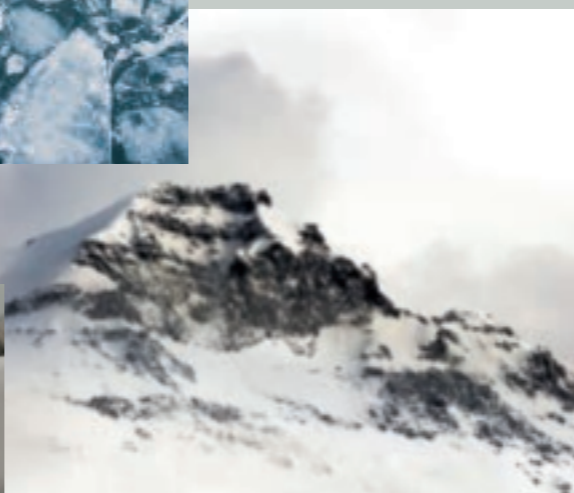

LA MONTAGNA ISPIRA AMBIENTI CALDI, SOPRATTUTTO QUANDO FA FREDDO FUORI. SE LA TEMPERATURA È RIGIDA, LO DIVENTA ANCHE IL DESIGN.



Mountains inspire warm settings, especially when it's cold outside. When the temperature drops, the design becomes more rigorous.

4

SNOW
inspiration mood



MAYA
letto _ bed

BETA
gruppo _ suite

GOLA
armadio _ wardrobe

↳ Letto **MAYA** in ecopelle Bianco
 Gruppo **BETA** in melaminico olmo Artico
 Armadio battente **GOLA** in melaminico olmo Artico

Bianco eco-leather **MAYA** bed
BETA suite: Artico melamine elm
GOLA hinged wardrobe: Artico melamine elm

Le tonalità chiare
 e i volumi pieni
 del gruppo
 vengono scaldati
 e ammorbiditi
 dalla testiera in
 ecopelle del letto.

The bed's eco-leather
 headboard softens
 and warms up the
 light shades and the
 volumes of the suite.

The groove handles draw straight lines on the dresser and bedside tables, interrupting surface continuity. The diagonal seams on the eco-leather headboard add a tone-on-tone decorative touch. Small details that make all the difference.



inspiration mood



COMÒ GRUPPO BETA

Chalet life style



Le aperture a gola disegnano sui frontali del comò e dei comodini delle linee rette che interrompono la continuità delle superfici. Anche le cuciture diagonali sulla testiera in ecopelle danno un tocco decorativo, sempre tono su tono. Piccoli dettagli che però fanno la differenza.

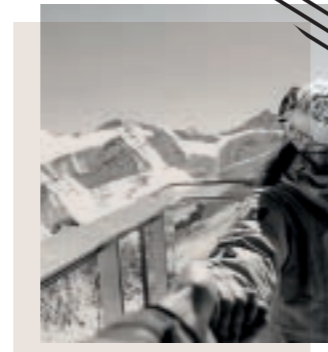



L'ARMADIO IN ESSENZA
 PORTA IL CALORE DELLE VENATURE
 NELLA NOTTE.

THE WARDROBE WITH A WOOD
 FINISH ADDS
 THE WARMTH OF ITS GRAIN.



night collection

inspiration mood

➔ Armadio battente **GOLA** in melaminico olmo Artico
GOLA hinged wardrobe: Artico melamine elm

LINEARITÀ E VOLUMI COMPATTI
CARATTERIZZANO TUTTI GLI ELEMENTI DELLA
CAMERA DA LETTO. PER CHI, NELLA SCELTA
DELL'ARREDO, VUOLE ANDARE SUL SICURO.

ALL THE ELEMENTS OF THE BEDROOM ARE
CHARACTERISED BY LINEARITY AND COMPACT
VOLUMES. FOR THOSE WHO PREFER SAFE CHOICES
WHEN IT COMES TO FURNITURE.

BETA

melaminico olmo Artico / Artico melamine elm
comodino / bedside table L 485 x H 366 x P 423 mm
comò / dresser L 1205 x H 671 x P 540 mm

gruppo _ suite



GOLA

battente melaminico olmo Artico / Artico melamine elm hinged wardrobe
L 2714 x H 2550 x P 622 mm

armadio _ wardrobe



letto _ bed

MAYA

ecopelle Bianco / Bianco eco-leather
L 1750 x H 1050 x P 2120 mm

Nature inspires settings that regenerate the body and mind. Perfect for finding harmony with oneself and the world around us.



WOOD

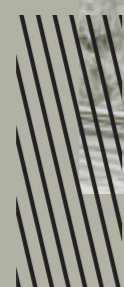

LA NATURA È FONTE DI ISPIRAZIONE PER AMBIENTI CHE RIGENERANO CORPO E MENTE. PER ESSERE IN ARMONIA CON SÉ STESSI E IL MONDO CIRCOSTANTE.

5

GREEN

inspiration mood

DORY

letto _ bed

WAY

gruppo _ suite

BASIC

armadio _ wardrobe

↳ Letto **DORY** in ecopelle Bianco con inserti in ecopelle Grigio medio
 Gruppo **WAY** in melaminico Ghiaccio
 Armadio scorrevole **BASIC** in melaminico Ghiaccio

DORY bed: Bianco eco-leather with medium Grigio eco-leather inserts
WAY suite: Ghiaccio melamine
BASIC sliding wardrobe: Ghiaccio melamine



La notte è
 essenziale nei
 toni, nelle forme
 e nelle finiture:
 superfici lisce
 per armadio ed
 elementi del
 gruppo, ecopelle
 in due tonalità
 per il letto.

This bedroom space is
 essential in its shades,
 shapes and finishes:
 smooth surfaces for
 the wardrobe and
 elements of the suite,
 two-tone eco-leather
 for the bed.



LETTO IMBOTTITO DORY



LA NATURA RISERVA SEMPRE
QUALCOSA DI INASPETTATO:
UN DOPPIO COLORE SULLA TESTIERA.

NATURE ALWAYS HAS A SURPRISE
IN STORE, LIKE THE DUAL COLOUR
ON THE HEADBOARD.



What's more natural than straight lines that draw simple geometrical shapes? The top drawer of the dresser and bedside table is shallower for smaller objects. A functional and aesthetically pleasing detail.

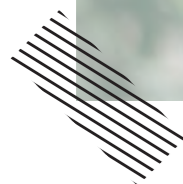

Natural style

inspiration mood

Non c'è niente di più naturale di linee dritte che disegnano forme geometriche semplici. Sul comò e anche sul comodino, il cassetto superiore ha un'altezza diversa e ridotta per creare spazi utili dove contenere gli oggetti più piccoli. Un dettaglio funzionale, ma anche estetico.



Dory + Way + Basic



Dory + Way + Basic

LA SEMPLICITÀ DELLE LINEE ACCOMUNA
TUTTI GLI ELEMENTI DELLA CAMERA DA LETTO.
UNA COMPOSIZIONE PENSATA PER CHI VIVE
LA NOTTE CON NATURALITÀ.

ALL THE ELEMENTS OF THE BEDROOM ARE
CHARACTERISED BY SIMPLE LINES.
A COMPOSITION DESIGNED FOR THOSE
WHO WANT TO EXPERIENCE THE NIGHT-TIME
SPACE NATURALLY.

WAY

melaminico olmo Artico / Artico melamine elm
comodino / bedside table L 385 x H 478 x P 443 mm - L 570 x H 368 x P 443 mm
comò / dresser L 1220 x H 769 x P 544 mm

gruppo _ suite



BASIC

scorrevole melaminico olmo Artico / Artico melamine elm sliding wardrobe
L 2714 x H 2550 x P 674 mm

armadio _ wardrobe



letto _ bed

DORY

ecopelle Bianco + inserti in ecopelle Grigio medio /
Bianco eco-leather + medium Grigio eco-leather inserts
L 1750 x H 1050 x P 2120 mm

free

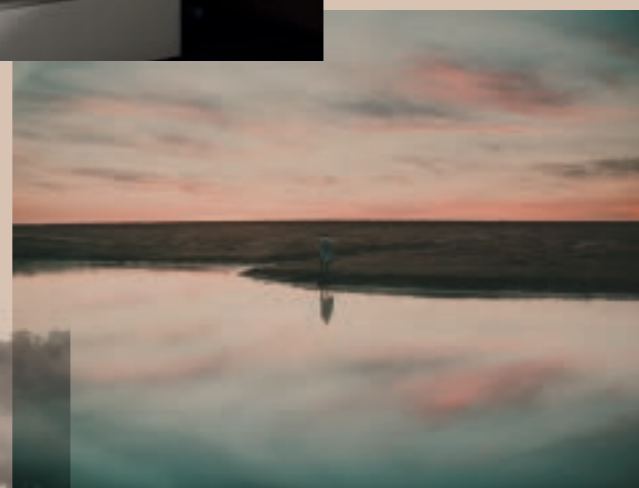

SPECCHI D'ACQUA
INCORNICIATI DA DOLCI RILIEVI
DIVENTANO ISPIRAZIONE
PER CREARE AMBIENTI INTIMI
E RACCOLTI.



Bodies of water
framed by soft slopes
inspire cosy and
intimate settings.

6

LAKE

inspiration mood



QUBO

letto _ bed

BETA

gruppo _ suite

BASIC

armadio _ wardrobe

↳ Letto **QUBO** in ecopelle Tortora
 Gruppo **BETA** in melaminico Ghiaccio
 Armadio scorrevole **BASIC** in melaminico Ghiaccio

QUBO bed: Tortora eco-leather
BETA suite: Ghiaccio melamine
BASIC sliding wardrobe: Ghiaccio melamine

Una tonalità
 calda per il
 letto imbottito,
 una finitura
 liscia e neutra
 per il gruppo
 e l'armadio:
 la notte gioca
 con i contrasti
 cromatici e
 materici.

A warm shade for
 the upholstered
 bed, a smooth and
 neutral finish for the
 suite and wardrobe:
 night-time plays
 with colour and
 texture contrasts.





UNA LAVORAZIONE SPECIALE
E TRAPUNTATA IMPREZIOSISCE
LA TESTIERA DEL LETTO.

THE SPECIAL QUILTED HEADBOARD
ADDS A PRECIOUS TOUCH
TO THE SETTING.



night collection

inspiration mood

NEL GRUPPO IL CASSETTO SUPERIORE
SPORGE LEGGERMENTE SUL TOP, NEL LETTO
LE IMPUNTURE DECORANO. PER CHI CERCA UNA
CAMERA CON UN TOCCO ORIGINALE.

THE SUITE FEATURES A SLIGHTLY PROTRUDING
TOP DRAWER, WHILE THE SEAMS DECORATE
THE BED. FOR THOSE WHO WANT A BEDROOM
WITH AN ORIGINAL TOUCH.

BETA

melaminico olmo Artico / Artico melamine elm
comodino / bedside table L 485 x H 366 x P 423 mm
comò / dresser L 1205 x H 671 x P 540 mm

gruppo _ suite



letto _ bed

QUBO

ecopelle Bianco / Bianco eco-leather
L 1750 x H 1050 x P 2126 mm

BASIC

scorrevole melaminico olmo Artico / Artico melamine elm sliding wardrobe
L 2714 x H 2550 x P 674 mm

armadio _ wardrobe



The Northern Lights paint the sky purple and inspire modern, fascinating settings.

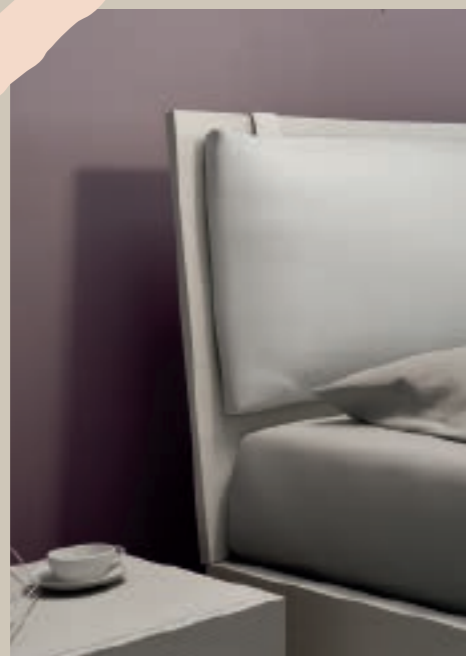

scandi

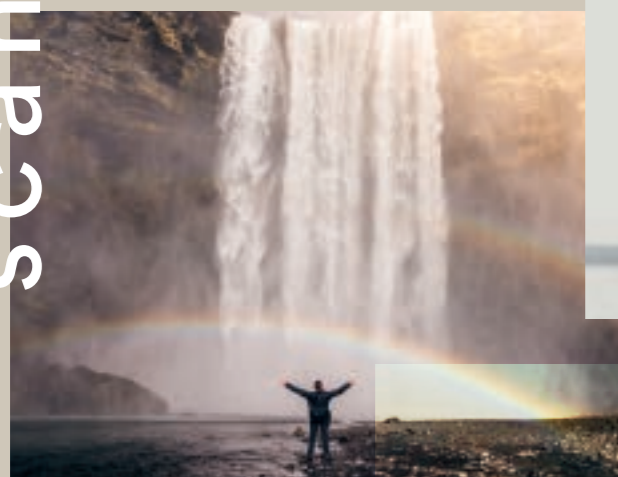

NELL'ESTREMO NORD,
L'AURORA BOREALE TINGE
IL CIELO DI VIOLA E ISPIRA
AMBIENTI MODERNI CHE
SANNO AFFASCINARE.

#7

NORTH

inspiration mood

SPARK

letto _ bed

WAY

gruppo _ suite

GOLA

armadio _ wardrobe

↳ Letto **SPARK** in melaminico olmo Artico con cuscini in ecopelle Bianco
 Gruppo **WAY** in melaminico olmo Artico
 Armadio battente **GOLA** in melaminico Ghiaccio

SPARK bed: Artico melamine elm with Bianco eco-leather pillows
WAY suite: Artico melamine elm
GOLA hinged wardrobe: Ghiaccio melamine

Venature sul
 gruppo e sul letto,
 finitura liscia per
 l'armadio, ecopelle
 per i cuscini
 della testiera:
 la zona notte crea
 abbinamenti unici.

The bedroom
 features unique
 combinations, thanks
 to the grain on the
 suite and bed, the
 smooth finish of the
 wardrobe, and the
 eco-leather on the
 headboard pillows.

The pillows add depth to the slim headboard and are the perfect accessories for those who like to read in bed.



LETTO IN LEGNO SPARK

I CUSCINI AGGIUNGONO
SPESSORE ALLA TESTIERA SOTTILE
E SONO UN ACCESSORIO PERFETTO
PER CHI AMA LEGGERE A LETTO.



LETTO IN LEGNO SPARK + CUSCINI

LE FORME MINIMALI SONO IL TRATTO
DISTINTIVO DELLA COMPOSIZIONE.
NEL LORO INSIEME, TUTTI GLI ARREDI DANNO
UN ASPETTO ELEGANTE ALLA NOTTE.

THE MINIMAL SHAPES ARE THE DISTINCTIVE
FEATURE OF THIS COMPOSITION.
TOGETHER, ALL THE FURNISHINGS DRESS
THE NIGHT WITH ELEGANCE.

WAY

melaminico olmo Artico / Artico melamine elm
comodino / bedside table L 385 x H 478 x P 443 mm - L 570 x H 368 x P 443 mm
comò / dresser L 1220 x H 769 x P 544 mm

gruppo _ suite



letto _ bed

SPARK

melaminico olmo Artico / Artico melamine elm
L1680 x H 982 x P 2163 mm

GOLA

battente melaminico olmo Artico / Artico melamine elm hinged wardrobe
L 2714 x H 2550 x P 674 mm

armadio _ wardrobe





technical details

letti / gruppi / armadi
beds / suites / wardrobes

↳ **Letti /** Beds

Letti in legno / Wooden beds

VIKI

L 1680 x H 925 x P 2153 mm



SKY

L 1690 x H 1020 x P 2060 mm



SPARK

L1680 x H 982 x P 2163 mm



Letti imbottiti / Upholstered beds

DORY

L 1750 x H 1050 x P 2120 mm



MAYA

L 1750 x H 1050 x P 2120 mm



QUBO

L 1750 x H 1050 x P 2126 mm



SMILE

L 1750 x H 1050 x P 2120 mm



↳ Gruppi / Suites

BETA

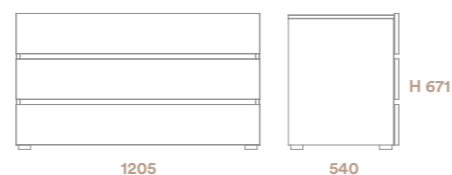
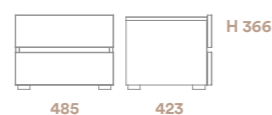

FINITURE / Finishes

Melaminico essenza / Melamine wood finish OLMO ARTICO
Melaminico colore / Melamine colour GHIACCIO

WAY

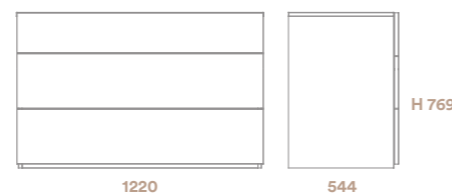
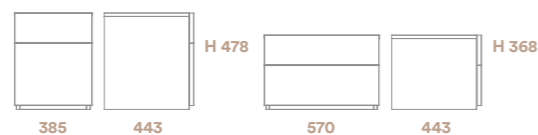

FINITURE / Finishes

Melaminico essenza / Melamine wood finish OLMO ARTICO
Melaminico colore / Melamine colour GHIACCIO

GLISS

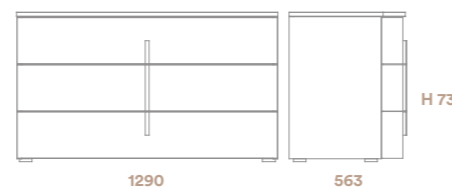
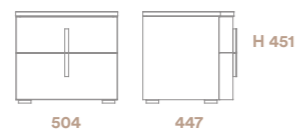

FINITURE / Finishes

Melaminico essenza / Melamine wood finish OLMO ARTICO
Melaminico colore / Melamine colour GHIACCIO

↳ Armadi / Wardrobes

Ante battenti / Hinged doors

DOOR



FINITURE / Finishes

Melaminico essenza / Melamine wood finish OLMO ARTICO
Melaminico colore / Melamine colour GHIACCIO
L 2714 H 2550 P 622 mm

GOLA



FINITURE / Finishes

Melaminico essenza / Melamine wood finish OLMO ARTICO
Melaminico colore / Melamine colour GHIACCIO
L 2714 H 2550 P 622 mm

Ante scorrevoli / Sliding doors

ARCO



FINITURE / Finishes

Melaminico essenza / Melamine wood finish OLMO ARTICO
Melaminico colore / Melamine colour GHIACCIO
L 2714 H 2550 P 674 mm

BASIC



FINITURE / Finishes

Melaminico essenza / Melamine wood finish OLMO ARTICO
Melaminico colore / Melamine colour GHIACCIO
L 2714 H 2550 P 674 mm

➔ Promozione camera 2018 / 2018 bedroom offer

Con l'acquisto di una camera completa (1 letto + 2 comodini + 1 comò + 1 armadio) **sconto extra del 5%** dal prezzo di listino.

Get an extra 5% off the list price when you buy a full bedroom set (1 bed + 2 nightstands + 1 dresser + 1 wardrobe).

Esempi di camere complete / Examples of full bedroom sets

Camera tipo 1 Bedroom style 1



Letto SKY giroletto sospeso
2 Comodini + 1 Comò WAY
1 Armadio 6 ante battenti DOOR

SKY bed frame on legs
2 nightstands + 1 dresser WAY
1 DOOR wardrobe with 6 hinged doors

PREZZO CAMERA COMPLETA
(esclusa di accessori)

FULL ROOM PRICE
(excluding accessories)

€ 2.339

Camera tipo 2 Bedroom style 2



Letto SPARK giroletto sospeso
2 Comodini + 1 Comò WAY
1 Armadio 6 ante battenti GOLA

SPARK bed frame on legs
2 nightstands + 1 dresser WAY
1 GOLA wardrobe with 6 grooved doors

PREZZO CAMERA COMPLETA
(esclusa di accessori)

FULL ROOM PRICE
(excluding accessories)

€ 2.552

Camera tipo 3 Bedroom style 3



Letto DORY giroletto a terra
2 Comodini + 1 Comò WAY
1 Armadio 2 ante scorrevoli BASIC

DORY bed with floor-standing bed frame
2 nightstands + 1 dresser WAY
1 BASIC wardrobe with 2 sliding doors

PREZZO CAMERA COMPLETA
(esclusa di accessori)

FULL ROOM PRICE
(excluding accessories)

€ 2.664

Letto Dory intercambiabile con i seguenti modelli senza sovrapprezzo: Maya, Smile e Qubo / The "Dory" bed is interchangeable with the Maya, Smile and Qubo models at no extra cost.

Camera tipo 4 Bedroom style 4



Letto QUBO giroletto a terra
2 Comodini + 1 Comò BETA
1 Armadio 2 ante scorrevoli BASIC

QUBO bed with floor-standing bed frame
2 nightstands + 1 dresser BETA
1 BASIC wardrobe with 2 sliding doors

PREZZO CAMERA COMPLETA
(esclusa di accessori)

FULL ROOM PRICE
(excluding accessories)

€ 2.714

Letto Qubo intercambiabile con i seguenti modelli senza sovrapprezzo: Maya, Dory e Smile / The "Qubo" bed is interchangeable with the Maya, Dory and Smile models at no extra cost.

Camera tipo 5 Bedroom style 5



Letto MAYA giroletto a terra
2 Comodini + 1 Comò BETA
1 Armadio 6 ante battenti GOLA

MAYA bed with floor-standing bed frame
2 nightstands + 1 dresser BETA
1 GOLA wardrobe with 6 grooved doors

PREZZO CAMERA COMPLETA
(esclusa di accessori)

FULL ROOM PRICE
(excluding accessories)

€ 2.752

Letto Maya intercambiabile con i seguenti modelli senza sovrapprezzo: Smile, Dory e Qubo / The "Maya" bed is interchangeable with the Smile, Dory and Qubo models at no extra cost.

Camera tipo 6 Bedroom style 6



Letto VIKI giroletto sospeso
2 Comodini + 1 Comò GLISS
1 Armadio 6 ante scorrevoli BASIC

VIKI bed frame on legs
2 nightstands + 1 dresser GLISS
1 BASIC wardrobe with 6 sliding doors

PREZZO CAMERA COMPLETA
(esclusa di accessori)

FULL ROOM PRICE
(excluding accessories)

€ 3.443

Camera tipo 7 Bedroom style 7



Letto SMILE giroletto a terra
2 Comodini + 1 Comò GLISS
1 Armadio 2 ante scorrevoli ARCO

SMILE bed with floor-standing bed frame
2 nightstands + 1 dresser GLISS
1 ARCO wardrobe with 2 sliding doors

PREZZO CAMERA COMPLETA
(esclusa di accessori)

FULL ROOM PRICE
(excluding accessories)

€ 3.723

Letto Smile intercambiabile con i seguenti modelli senza sovrapprezzo: Maya, Dory e Qubo / The "Smile" bed is interchangeable with the Maya, Dory and Qubo models at no extra cost.

➔ Nel prezzo non sono compresi: cassetiera interna, divisorio con ripiani, il materasso, i guanciali, la rete, il kit alza letto e i cuscini. Tutti i prezzi sono IVA esclusa. / The price does not include: internal drawer unit, partition with shelves, mattress, pillows, bed springs, bed-frame lifting kit, decorative cushions. VAT not included.

➔ Nel prezzo non sono compresi: cassetiera interna, divisorio con ripiani, il materasso, i guanciali, la rete, il kit alza letto e i cuscini. Tutti i prezzi sono IVA esclusa. / The price does not include: internal drawer unit, partition with shelves, mattress, pillows, bed springs, bed-frame lifting kit, decorative cushions. VAT not included.

→ **Finiture** / Finishes

Melaminico essenza / Melamine wood finish



OLMO ARTICO

Melaminico colore / Melamine colour

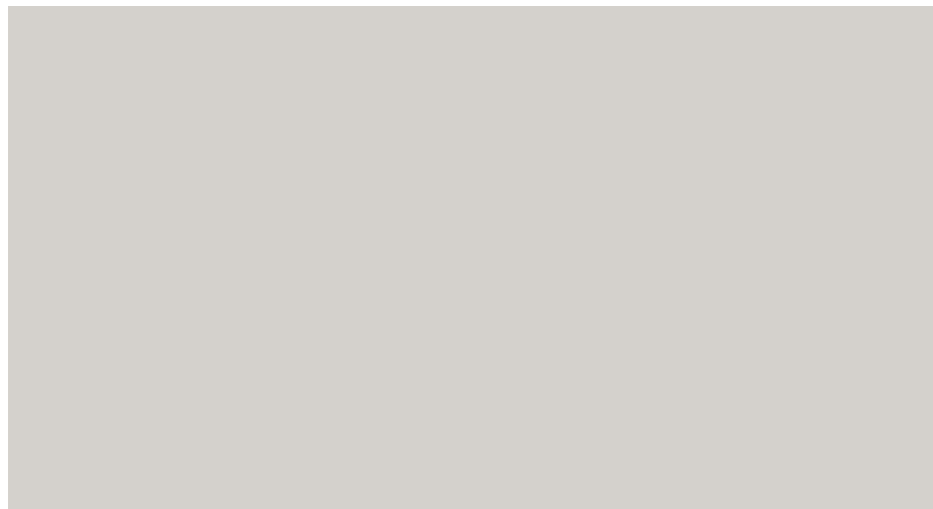

GHIACCIO

Ecopelli / Eco-leathers

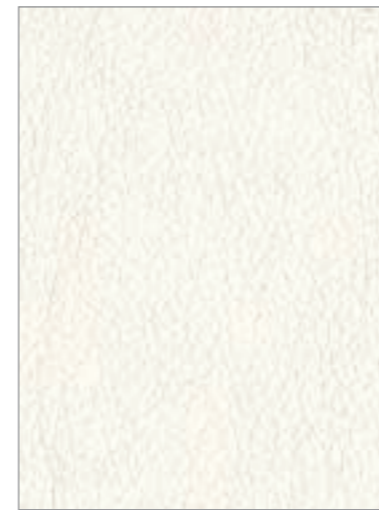

BIANCO



TORTORA



GRIGIO MEDIO
solo per inserto letto Dory
only for Dory bed insert



price list

letti / gruppi / armadi
beds / suites / wardrobes

↳ Letti / Beds

| | |
|--------------|---------|
| Sky | page 82 |
| Spark | page 83 |
| Viki | page 84 |
| Dory | page 85 |
| Maya | page 86 |
| Qubo | page 87 |
| Smile | page 88 |

↳ Gruppi / Suites

| | |
|--------------|---------|
| Way | page 90 |
| Beta | page 91 |
| Gliss | page 92 |

↳ Specchiere / Mirrors

page 93

↳ Reti e materassi / Slats and mattresses

page 94

↳ Guanciali / Pillows

page 95

↳ Armadi / Wardrobes

| | |
|--------------|---------|
| Door | page 96 |
| Gola | page 96 |
| Basic | page 97 |
| Arco | page 97 |

↳ Accessori / Accessories

page 98-99

SKY GIROLETTO CORNER / CORNER BED FRAME

Testiera: Non retrofinita
Headboard: Unfinished on the back



Giroletto sospeso
Bed frame on legs

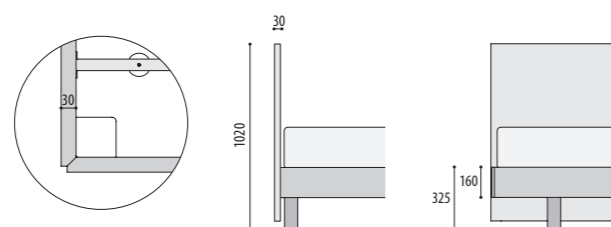

Giroletto a terra e contenitore Floor-standing bed frame with storage base

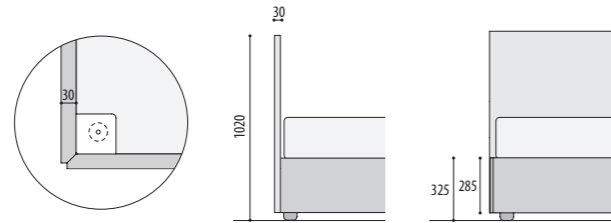

OPTIONAL
OPTIONAL



Coppia cuscini finitura Eco-pelle
(vedi pag. 95)
Pair of eco-leather finished cushions
(see page 95)

Rete Bed base L 1600 P 1950
Vano interno Interior compartment L 1620 P 2000
Misure esterne Exterior measurements L 1690 H 1020 P 2060

| Disegno Drawing | Ring Ring | Finiture Finishes | Misure reti Slats dimensions 1600 | Kg. | m ³ |
|--------------------|--|--|---|-----|----------------|
| | SKY giroletto Corner sospeso SKY bed with Corner bed frame on legs | Melaminico: Olmo artico / Ghiaccio Melamine: Olmo artico / Ghiaccio | Q516 409 | 70 | 0,169 |
| | SKY giroletto Corner a terra SKY bed frame Corner to the ground | Melaminico: Olmo artico / Ghiaccio Melamine: Olmo artico / Ghiaccio | Q526 422 | 86 | 0,194 |
| | SKY giroletto Corner a terra con contenitore 1 posizione SKY bed with Corner floor-standing bed frame with storage base and 1-position lift-up mechanism | Melaminico: Olmo artico / Ghiaccio Melamine: Olmo artico / Ghiaccio | Q536 792 | 144 | 0,363 |

Profondità disponibile per inserimento reti con telaio max. H 50 mm - Non si esegue nessun tipo di lavorazione fuori misura
Depth suitable to fit max 50 mm high bed bases with frames - No custom-sizing is available

SPARK GIROLETTO CORNER / CORNER BED FRAME



Giroletto sospeso
Bed frame on legs

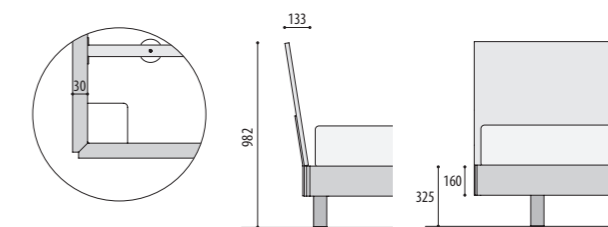

Giroletto a terra e contenitore Floor-standing bed frame with storage base

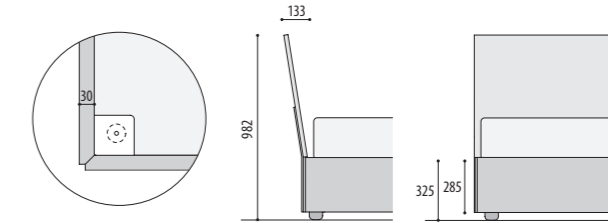

Testiera: Non retrofinita
Headboard: Unfinished on the back

OPTIONAL
OPTIONAL



Coppia cuscini finitura Eco-pelle
(vedi pag. 95)
Pair of eco-leather finished cushions
(see page 95)

Rete Bed base L 1600 P 1950
Vano interno Interior compartment L 1620 P 2000
Misure esterne Exterior measurements L 1680 H 982 P 2163

| Disegno Drawing | Ring Ring | Finiture Finishes | Misure reti Slats dimensions 1600 | Kg. | m ³ |
|--------------------|--|--|---|-----|----------------|
| | SPARK giroletto Corner sospeso SPARK bed with Corner bed frame on legs | Melaminico: Olmo artico / Ghiaccio Melamine: Olmo artico / Ghiaccio | Q1042 449 | 60 | 0,169 |
| | SPARK giroletto Corner SPARK bed frame Corner | Melaminico: Olmo artico / Ghiaccio Melamine: Olmo artico / Ghiaccio | Q1142 463 | 76 | 0,194 |
| | SPARK giroletto Corner con contenitore 1 posizione SPARK bed with Corner floor-standing bed frame with storage base and 1-position lift-up mechanism | Melaminico: Olmo artico / Ghiaccio Melamine: Olmo artico / Ghiaccio | Q1242 833 | 134 | 0,363 |

Profondità disponibile per inserimento reti con telaio max. H 50 mm - Non si esegue nessun tipo di lavorazione fuori misura
Depth suitable to fit max 50 mm high bed bases with frames - No custom-sizing is available

VIKI GIROLETTO SOSPEO E A TERRA / BED FRAME ON LEGS AND FLOOR-STANDING

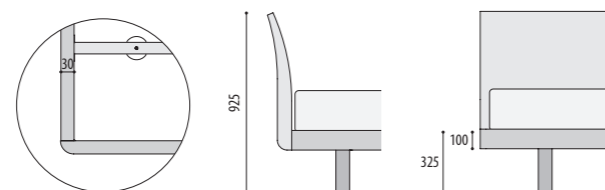
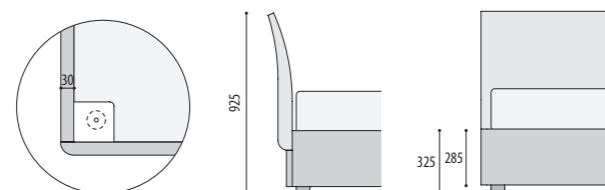
Giroletto sospeso
Bed frame on legs

Giroletto a terra
Bed frame ground

Testiera: Non retrofinita
Headboard: Unfinished on the back

Rete
Bed base
L 1600 P 1950
Vano interno
Interior compartment
L 1620 P 2000
Misure esterne
Exterior measurements
L 1680 H 925 P 2153

| Disegno Drawing | Ring Ring | Finiture Finishes | Misure reti Slats dimensions | | | |
|--------------------|---|--|---------------------------------|--------------|----------------|-------|
| | | | 1600 | Kg. | m ³ | |
| | VIKI giroletto sospeso VIKI Bed frame on legs | Melaminico: Olmo artico / Ghiaccio Melamine: Olmo artico / Ghiaccio | Codice Code | Q581 | | |
| | | | | 712 | 60 | 0,210 |
| | VIKI giroletto a terra VIKI bed with floor-standing bed frame | Melaminico: Olmo artico / Ghiaccio Melamine: Olmo artico / Ghiaccio | Codice Code | Q586 | | |
| | | | | 755 | 75 | 0,310 |
| | VIKI giroletto a terra con contenitore 1 posizione VIKI floor-standing bed frame with storage base and 1-position lift-up mechanism | Melaminico: Olmo artico / Ghiaccio Melamine: Olmo artico / Ghiaccio | Codice Code | Q588 | | |
| | | | | 1.110 | 133 | 0,479 |

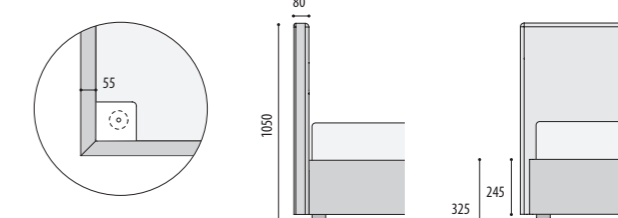
Profondità disponibile per inserimento reti con telaio max. H 50 mm - Non si esegue nessun tipo di lavorazione fuori misura
Depth suitable to fit max 50 mm high bed bases with frames - No custom-sizing is available

DORY TESTIERA E GIROLETTO IMBOTTITI / UPHOLSTERED HEADBOARDS AND BED FRAMES

Giroletto a terra e contenitore
Floor-standing bed frame with storage base

Testiera:
• Non sfoderabile
• Non retrofinita
Giroletto:
• Non sfoderabile
Headboard:
• Non-removable fabric
• Unfinished on the back
Bed frame:
• Non-removable fabric

Rete
Bed base
L 1600 P 1950
Vano interno
Interior compartment
L 1620 P 2000
Misure esterne
Exterior measurements
L 1750 H 1050 P 2120

| Disegno Drawing | Ring Ring | Finiture Finishes | Misure reti Slats dimensions | | | |
|--------------------|--|--|---------------------------------|--------------|----------------|-------|
| | | | 1600 | Kg. | m ³ | |
| | DORY giroletto a terra DORY bed with floor-standing bed frame | Ecopelle Bianco con particolari Grigio medio Bianco eco-leather with Grigio medio details | Codice Code | Q1076 | | |
| | | | | 599 | 88 | 0,420 |
| | DORY giroletto a terra con contenitore 1 posizione DORY bed with floor-standing bed frame with storage base and 1-position lift-up mechanism | Ecopelle Bianco con particolari Grigio medio Bianco eco-leather with Grigio medio details | Codice Code | Q1086 | | |
| | | | | 945 | 149 | 0,590 |

Profondità disponibile per inserimento reti con telaio max. H 50 mm - Non si esegue nessun tipo di lavorazione fuori misura
Depth suitable to fit max 50 mm high bed bases with frames - No custom-sizing is available

MAYA TESTIERA E GIROLETTO IMBOTTITI / UPHOLSTERED HEADBOARDS AND BED FRAMES

Giroletto a terra e contenitore
Floor-standing bed frame with storage base

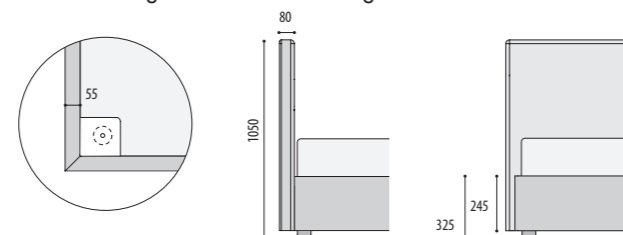

Testiera:
 • Non sfoderabile
 • Non retrofinita
Giroletto:
 • Non sfoderabile
Headboard:
 • Non-removable fabric
 • Unfinished on the back
Bed frame:
 • Non-removable fabric

Rete
Bed base
L 1600 P 1950

Vano interno
Interior compartment
L 1620 P 2000

Misure esterne
Exterior measurements
L 1750 H 1050 P 2120

| Disegno Drawing | Ring Ring | Finiture Finishes | Misure reti Slats dimensions | | | |
|--------------------|--|--|---------------------------------|-------|----------------|-------|
| | | | 1600 | Kg. | m ³ | |
| | MAYA giroletto a terra MAYA bed with floor-standing bed frame | Eco-pelle: Bianco / Tortora Eco-leather: Bianco / Tortora | Codice Code | Q1046 | | |
| | | | | 599 | 88 | 0,420 |
| | MAYA giroletto a terra con contenitore 1 posizione MAYA bed with floor-standing bed frame with storage base and 1-position lift-up mechanism | Eco-pelle: Bianco / Tortora Eco-leather: Bianco / Tortora | Codice Code | Q1056 | | |
| | | | | 945 | 149 | 0,590 |

Profondità disponibile per inserimento reti con telaio max. H 50 mm - Non si esegue nessun tipo di lavorazione fuori misura
Depth suitable to fit max 50 mm high bed bases with frames - No custom-sizing is available

QUBO TESTIERA E GIROLETTO IMBOTTITI / UPHOLSTERED HEADBOARDS AND BED FRAMES

Giroletto a terra e contenitore
Floor-standing bed frame with storage base

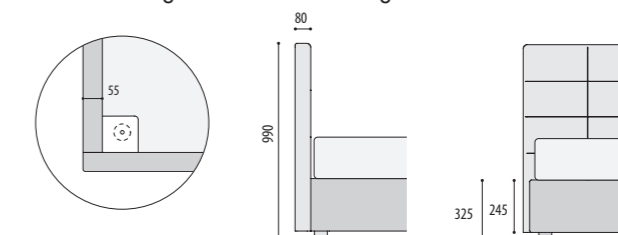

Letto: non sfoderabile e non retrofinito
Bed: non-removable fabric and unfinished on the back

Rete
Bed base
L 1600 P 1950

Vano interno
Interior compartment
L 1620 P 2000

Misure esterne
Exterior measurements
L 1750 H 1050 P 2126

| Disegno Drawing | Ring Ring | Finiture Finishes | Misure reti Slats dimensions | | | |
|--------------------|--|--|---------------------------------|-------|----------------|-------|
| | | | 1600 | Kg. | m ³ | |
| | QUBO giroletto a terra QUBO bed with floor-standing bed frame | Eco-pelle: Bianco / Tortora Eco-leather: Bianco / Tortora | Codice Code | Q1144 | | |
| | | | | 599 | 81 | 0,400 |
| | QUBO giroletto a terra con contenitore 1 posizione QUBO bed with floor-standing bed frame with storage base and 1-position lift-up mechanism | Eco-pelle: Bianco / Tortora Eco-leather: Bianco / Tortora | Codice Code | Q1244 | | |
| | | | | 945 | 139 | 0,570 |

Profondità disponibile per inserimento reti con telaio max. H 50 mm - Non si esegue nessun tipo di lavorazione fuori misura
Depth suitable to fit max 50 mm high bed bases with frames - No custom-sizing is available

SMILE GIROLETTO CORNER / CORNER BED FRAME



Giroletto a terra e contenitore
Floor-standing bed frame with storage base

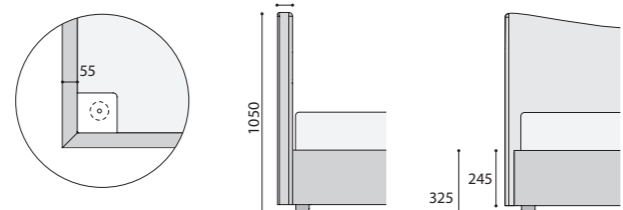

Testiera:
 · Non sfoderabile
 · Non retrofinita
Giroletto:
 · Non sfoderabile
Headboard:
 · Non-removable fabric
 · Unfinished on the back
Bed frame:
 · Non-removable fabric

Rete
Bed base
L 1600 P 1950

Vano interno
Interior compartment
L 1620 P 2000

Misure esterne
Exterior measurements
L 1750 H 1050 P 2120

| Disegno Drawing | Ring Ring | Finiture Finishes | Misure reti Slats dimensions 1600 | Kg. | m ³ |
|--------------------|--|---|---|-----|----------------|
| | SMILE giroletto a terra SMILE bed with floor-standing bed frame | Eco-pelle: Bianco / Tortora Eco-leather: Bianco / Tortora | Q1120 599 | 105 | 0,230 |
| | SMILE giroletto a terra con contenitore 1 posizione SMILE bed with floor-standing bed frame with storage base and 1-position lift-up mechanism | Eco-pelle: Bianco / Tortora Eco-leather: Bianco / Tortora | Q1130 945 | 163 | 0,400 |

Profondità disponibile per inserimento reti con telaio max. H 50 mm - Non si esegue nessun tipo di lavorazione fuori misura
Depth suitable to fit max 50 mm high bed bases with frames - No custom-sizing is available

CARATTERISTICHE TECNICHE SISTEMA GIROLETTI / TECHNICAL FEATRES OF THE BED FRAME SYSTEM

GIROLETTO CORNER SOSPESO
validi per i letti: SKY - SPARK
CORNER BED FRAME ON LEGS
for: SKY - SPARK

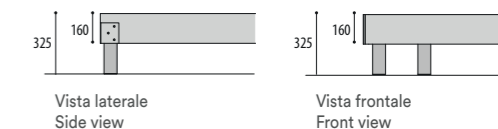
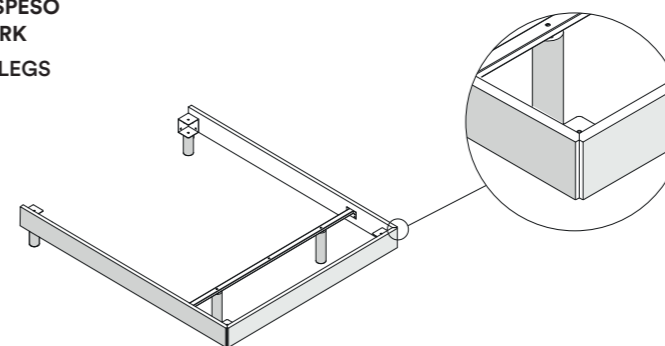

GIROLETTO CORNER A TERRA
validi per i letti: SKY - SPARK
FLOOR - STANDING CORNER BED FRAME
for: SKY - SPARK

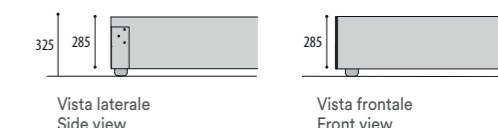
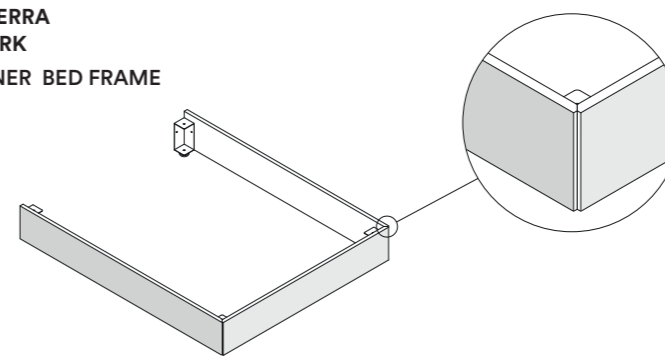

GIROLETTO SOSPESO
validi per i letti: VIKI
UPHOLSTERED BED FRAME ON LEGS
for: VIKI

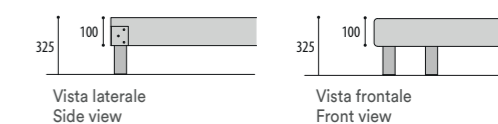
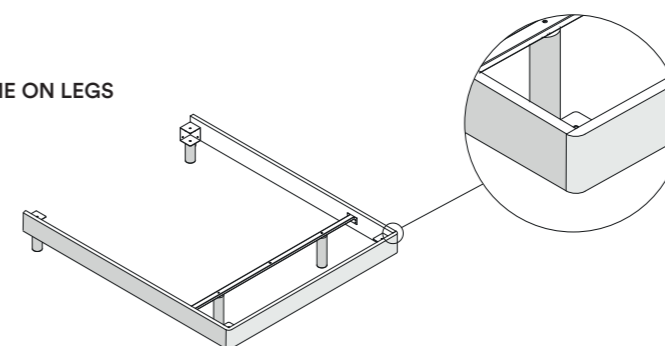

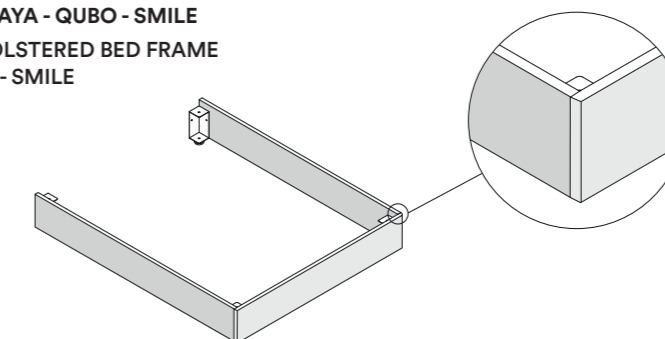

GIROLETTO IMBOTTITO A TERRA
validi per i letti: DORY - MAYA - QUBO - SMILE
FLOOR - STANDING UPHOLSTERED BED FRAME
for: DORY - MAYA - QUBO - SMILE



WAY GRUPPO LETTO / BEDROOM FURNITURE

Di serie presa maniglia laterale
Side grip recess supplied standard

N.B. Tutti i cassetti sono dotati di guide con chiusura rallentata
Non si esegue nessun tipo di lavorazione fuori misura
N.B. All drawers have runners with soft closing
No custom-sizing is available

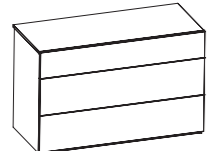
| Disegno Drawing | Descrizione Description | Finiture Finishes | Codice Code | Prezzo Price | Kg. | m ³ |
|--|---|--|----------------|-----------------|-----|----------------|
|  | L 385 x H 478 x P 443 WAY comodino 2 cassetti WAY 2 bedside drawers | Melaminico: Olmo artico / Ghiaccio Melamine: Olmo artico / Ghiaccio | GS60 | 165 | 17 | 0,107 |
|  | L 570 x H 368 x P 443 WAY comodino 2 cassetti WAY 2 bedside drawers | Melaminico: Olmo artico / Ghiaccio Melamine: Olmo artico / Ghiaccio | GS61 | 165 | 18 | 0,128 |
|  | L 1220 x H 769 x P 544 WAY comò 3 cassetti WAY 3 drawer dresser | Melaminico: Olmo artico / Ghiaccio Melamine: Olmo artico / Ghiaccio | GS62 | 342 | 61 | 0,610 |

BETA GRUPPO LETTO / BEDROOM FURNITURE

Di serie presa maniglia laterale
Side grip recess supplied standard

N.B. Tutti i cassetti sono dotati di guide con chiusura rallentata
Non si esegue nessun tipo di lavorazione fuori misura
N.B. All drawers have runners with soft closing
No custom-sizing is available

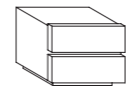
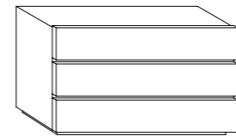
| Disegno Drawing | Descrizione Description | Finiture Finishes | Codice Code | Prezzo Price | Kg. | m ³ |
|---|---|--|----------------|-----------------|-----|----------------|
|  | L 485 x H 366 x P 423 BETA comodino 2 cassetti BETA 2 bedside drawers | Melaminico: Olmo artico / Ghiaccio Melamine: Olmo artico / Ghiaccio | GV74 | 173 | 15 | 0,108 |
|  | L 1205 x H 671 x P 540 BETA comò 3 cassetti BETA 3 drawer dresser | Melaminico: Olmo artico / Ghiaccio Melamine: Olmo artico / Ghiaccio | GV79 | 376 | 88 | 0,542 |

GLISS GRUPPO LETTO / BEDROOM FURNITURE





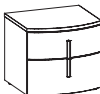
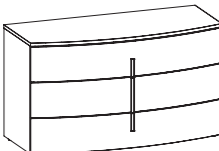

N.B. Tutti i cassetti sono dotati di guide con chiusura rallentata
Non si esegue nessun tipo di lavorazione fuori misura
N.B. All drawers have runners with soft closing
No custom-sizing is available



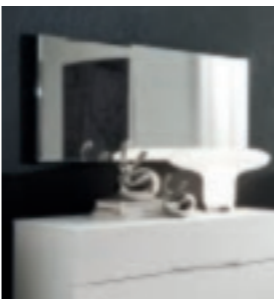

| Disegno Drawing | Descrizione Description | Finiture Finishes | Prezzo Price | Kg. | m ³ |
|---|---|--|-----------------|------|----------------|
| | | Codice Code | GT41 | | |
|  | L 504 x H 451 x P 447 GLISS comodino 2 cassetti GLISS 2 bedside drawers | Melaminico: Olmo artico / Ghiaccio Melamine: Olmo artico / Ghiaccio | 330 | 15,6 | 0,123 |
| | | Codice Code | GT42 | | |
|  | L 1290 x H 739 x P 563 GLISS comò 3 cassetti GLISS 3 drawer dresser | Melaminico: Olmo artico / Ghiaccio Melamine: Olmo artico / Ghiaccio | 678 | 46 | 0,602 |

SPECCHIERE / MIRRORS

| Disegno Drawing | Descrizione Description | Finiture Finishes | Prezzo Price | Kg. | m ³ |
|---|---|--|-----------------|-----|----------------|
|  | L 1200 x H 720 x sp. 22 Specchiera WAY WAY mirror | | SP14 | | |
| | | Melaminico: Olmo artico / Ghiaccio Melamine: Olmo artico / Ghiaccio | 123 | 14 | 0,069 |
| | N.B. Possibilità di appenderla verticale o orizzontale N.B. Can be horizontally or vertically hung | | | | |
|  | L 520 x H 1750 x sp. 22 Specchiera HOME HOME mirror | | SP18 | | |
| | | Melaminico: Olmo artico / Ghiaccio Melamine: Olmo artico / Ghiaccio | 139 | 14 | 0,074 |
|  | L 1130 x H 640 x sp. 22 Specchiera JOY JOY mirror | | SP13 | | |
| | | Specchio Mirror | 131 | 12 | 0,059 |
| | N.B. Possibilità di appenderla verticale o orizzontale N.B. Can be horizontally or vertically hung | | | | |
| | | Kit di illuminazione Lighting kit | 134 | 0,6 | 0,004 |
|  | L 1100 x H 700 x sp. 22 Specchiera OVALE Ovale mirror | | SP16 | | |
| | | Specchio Mirror | 205 | 13 | 0,062 |
| | N.B. Possibilità di appenderla verticale o orizzontale N.B. Can be horizontally or vertically hung | | | | |
| | | Kit di illuminazione Lighting kit | 221 | 0,6 | 0,004 |

Non si esegue nessun tipo di lavorazione fuori misura
No custom-sizing is available

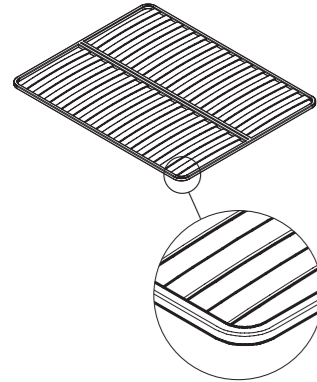
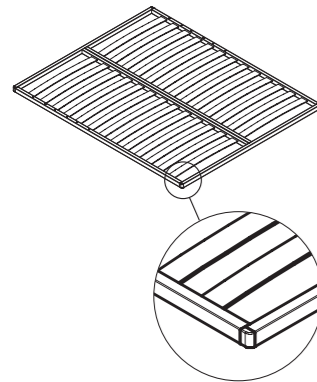
RETI - MATERASSI / SLATS - MATTRESSES

| Disegno Drawing | Descrizione Description | Misure Dimensions | Codice Code | Prezzo Price | Kg. | m ³ |
|--|--|--|----------------|-----------------|------|----------------|
|  | Rete GREY ortopedica con doghe Rete ortopedica composta da un telaio realizzato con tubolare in metallo verniciato da 23 x 30 mm, nel quale vengono inseriti listelli curvati spessore 8 mm in multistrati di faggio. GREY orthopaedic bed base Orthopaedic bed base made from a 23 x 30 mm painted tubular metal frame into which 8 mm thick beech multiplayer slats are fitted. | L 1600 x P 1970 x Sp. 30 Per vano interno 1620 x 2000 W 1600 x D 1970 x Th. 30 For Interior compartment 1620 x 2000 | RE01 | 157 | 14 | 0,069 |
|  | Rete STAY ortopedica con doghe Rete ortopedica composta da un telaio realizzato con tubolare in metallo verniciato da 30 x 40 mm, nel quale vengono inseriti listelli curvati spessore 8 mm in multistrati di faggio. STAY orthopaedic bed base with slats Orthopaedic bed base made from a 30 x 40 mm painted tubular metal frame into which 8 mm thick beech multiplayer slats are fitted. | L 1600 x P 1950 x Sp. 40 Per vano interno 1620 x 2000 W 1600 x D 1950 x Th. 40 For Interior compartment 1620 x 2000 | RE31 | 190 | 27,4 | 0,096 |
|  | DREAM molle in acciaio temperato diametro 2,2 mm; perimetri rinforzati in P.U.H.D.; isolante in lastre di fibra pressata anallergica imbottitura climatizzata da ambo i lati, rivestimento misto cotone\poliestere, finitura trapuntata. DREAM 2.2-mm diameter, tempered steel springs; P.U.H.D strengthened perimeter; non-allergenic, pressed fibre insulation, breathable padding on both sides covered with mixed cotton\polyester fabric, quilted finish. | L 1600 x P 1950 x Sp. 210 W 1600 x D 1950 x Th. 210 | MA11 | 356 | 27 | 0,655 |
|  | RIGHT molle in acciaio temperato diametro 2,2 mm; perimetri rinforzati in P.U.H.D.; isolante in lastra di feltro pressato; supporto con lastra schiumata ad acqua ad alta densità da ambo i lati, imbottitura climatizzata da entrambi i lati, rivestimento e fasce perimetrali in tessuto misto cotone\poliestere, finitura trapuntata. RIGHT 2.2-mm diameter, tempered steel springs; P.U.H.D strengthened perimeters; pressed felt insulation; supported by a layer of high-density, water-based foam on both sides, breathable padding on both sides, covered all over including the perimeter with mixed cotton\polyester fabric, quilted finish. | L 1600 x P 1950 x Sp. 210 W 1600 x D 1970 x Th. 210 | MA01 | 356 | 27 | 0,655 |

Non si esegue nessun tipo di lavorazione fuori misura
No custom-sizing is available

GUANCIALE / PILLOW

| Disegno Drawing | Descrizione Description | Misure Dimensions | Codice Code | Prezzo Price | Kg. | m ³ |
|---|---|--|----------------|-----------------|-----|----------------|
|  | Modello FLOWER guanciaie Federa in misto cotone-poliestere (600 gr. circa) imbottitura in poliestere lavabile in lavatrice max 30°. FLOWER model pillow Mixed cotton-polyester (approx. 600 g) cover, padded with polyester, machine washable at max 30°. | L 700 x P 400 W 700 x D 400 | K901 | 14 | 0,7 | 0,021 |
|  | Modello SHAPE guanciaie (memory sagomato) Federa in misto cotone-poliestere (600 gr. circa) imbottitura in memory form schiumato a stampo. Non lavabile. SHAPE model pillow (shaped memory foam) Mixed cotton-polyester (approx. 600 g) cover, padded with moulded memory foam. Cannot be washed. | L 700 x P 400 W 700 x D 400 | K902 | 54 | 0,7 | 0,021 |
|  | Coppia di cuscini disponibili in Eco-pelle Bianco o Tortora sfoderabili e retrofiniti Pair of cushions available in White or Dove-grey eco-leather with removable covers. Finished on rear. | L 800 x H 470 x Sp. 120 Misura cuscino singolo W 800 x H 400 x Th. 120 Single pillow size | K134 | 222 | 2 | 0,108 |

Non si esegue nessun tipo di lavorazione fuori misura
No custom-sizing is available

DOOR COMPOSIZIONI ARMADI BATTENTI / HINGED DOOR WARDROBE ARRANGEMENTS

N.B.: i fianchi sono calcolati nella stessa finitura delle ante.

N.B.: the side panels are calculated in the same finish as the doors.

Dotazione di serie per ogni vano:
1 fondo, 1 coperchio, 1 ripiano sp. 30 mm, 2 tubi appendiabiti, 1 schiena,
1 battuta para polvere, chiusura rallentata (su ogni singola anta).
Maniglia di Serie cod. A320 finitura Alluminio

Standard accessories for each module:
1 bottom panel, 1 top panel, 1x30-mm thick shelf, 2 hanging rails, 1 back panel,
1 door jamb dust seal, soft-close mechanism (for each single door).
Standard handle code A320 Aluminium finish

| | | H | | |
|----------------------|--|---|-----|----------------|
| Finiture Finishes | | 2550 | Kg. | m ³ |
| L / W 1816 | | WM103 | | |
| | | 971 | 196 | 1,130 |
| | | Melaminico: Olmo artico / Ghiaccio Melamine: Olmo artico / Ghiaccio | | |
| L / W 2714 | | WM101 | | |
| | | 1.258 | 291 | 1,640 |
| | | Melaminico: Olmo artico / Ghiaccio Melamine: Olmo artico / Ghiaccio | | |

GOLA COMPOSIZIONI ARMADI BATTENTI / HINGED DOOR WARDROBE ARRANGEMENTS

N.B.: i fianchi sono calcolati nella stessa finitura delle ante.

N.B.: the side panels are calculated in the same finish as the doors.

Dotazione di serie per ogni vano:
1 fondo, 1 coperchio, 1 ripiano sp. 30 mm, 2 tubi appendiabiti, 1 schiena,
1 battuta para polvere, chiusura rallentata (su ogni singola anta).
1 profilo maniglia in alluminio.

Standard accessories for each module:
1 bottom panel, 1 top panel, 1x30-mm thick shelf, 2 hanging rails, 1 back panel,
1 door jamb dust seal, soft-close mechanism (for each single door).
1 aluminium grip edging.

| | | H | | |
|----------------------|--|---|-----|----------------|
| Finiture Finishes | | 2550 | Kg. | m ³ |
| L / W 1816 | | WM104 | | |
| | | 1.021 | 196 | 1,130 |
| | | Melaminico: Olmo artico / Ghiaccio Melamine: Olmo artico / Ghiaccio | | |
| L / W 2714 | | WM102 | | |
| | | 1.431 | 291 | 1,640 |
| | | Melaminico: Olmo artico / Ghiaccio Melamine: Olmo artico / Ghiaccio | | |

Non si esegue nessun tipo di lavorazione fuori misura
No custom-sizing is available

BASIC COMPOSIZIONI ARMADI SCORREVOLI / SLIDING DOOR WARDROBE ARRANGEMENTS

N.B.: i fianchi sono calcolati nella stessa finitura delle ante.

N.B.: the side panels are calculated in the same finish as the doors.

Dotazione di serie per ogni vano:
1 fondo, 1 coperchio, 1 ripiano sp. 30 mm, 2 tubi appendiabiti, 1 schiena, 1 binario,
chiusura rallentata (su ogni singola anta).
Maggiorazione prezzo apertura rallentata per ogni singola anta art. KIT7 € +42

Standard accessories for each module:
1 bottom panel, 1 top panel, 1x30-mm thick shelf, 2 hanging rails, 1 back panel, 1 track,
soft-close mechanism (for each single door).
Surcharge for soft-opening mechanism for each single door, item KIT7 € +42

| | | H | | |
|----------------------|--|---|-----|----------------|
| Finiture Finishes | | 2550 | Kg. | m ³ |
| L / W 2714 | | WU180 | | |
| | | 1.393 | 244 | 0,990 |
| | | Melaminico: Olmo artico / Ghiaccio Melamine: Olmo artico / Ghiaccio | | |

ARCO COMPOSIZIONI ARMADI SCORREVOLI / SLIDING DOOR WARDROBE ARRANGEMENTS

N.B.: i fianchi sono calcolati nella stessa finitura delle ante.

N.B.: the side panels are calculated in the same finish as the doors.

Dotazione di serie per ogni vano:
1 fondo, 1 coperchio, 1 ripiano sp. 30 mm, 2 tubi appendiabiti, 1 schiena, 1 binario,
chiusura rallentata (su ogni singola anta).
Maggiorazione prezzo apertura rallentata per ogni singola anta art. KIT7 € +42

Standard accessories for each module:
1 bottom panel, 1 top panel, 1x30-mm thick shelf, 2 hanging rails, 1 back panel, 1 track,
soft-close mechanism (for each single door).
Surcharge for soft-opening mechanism for each single door, item KIT7 € +42

| | | H | | |
|----------------------|--|---|-----|----------------|
| Finiture Finishes | | 2550 | Kg. | m ³ |
| L / W 2714 | | WU182 | | |
| | | 1.786 | 266 | 0,990 |
| | | Melaminico: Olmo artico / Ghiaccio Melamine: Olmo artico / Ghiaccio | | |



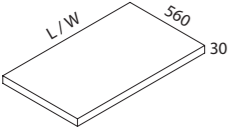
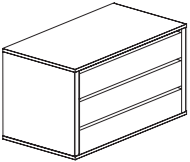
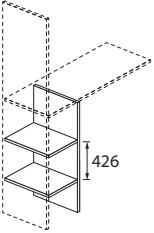
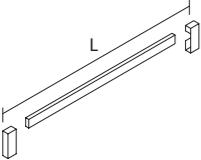
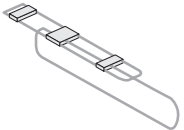

Non si esegue nessun tipo di lavorazione fuori misura
No custom-sizing is available

ACCESSORI PER MODULI / ACCESSORIES FOR MODULES

| Disegno Drawing | Descrizione Description | Misure Dimensions | Codice Code | Melaminico | Kg. | m ³ |
|---|---|---|----------------|----------------------|-------|----------------|
| | | | | Melamine Ghiaccio | | |
|  | Ripiano interno P. 560 sp. 30 Interior shelf D 560 - 30-mm thick | L 875 per armadi battenti W 875 for hinged door wardrobe | I701 | 59 | 9,5 | 0,050 |
| | | L 1324 per armadi scorrevoli W 1324 for sliding door wardrobe | I702 | 72 | 13,40 | 0,060 |
|  | Cassettiera interna H. 490 x P. 500 3 cassetti Interior drawer unit H 490 x D 500 3 drawers | L 875 W 875 | CL52 | 172 | 29 | 0,178 |
| | | | | | | |
|  | Divisorio con 2 ripiani Partition with 2 shelves | L 448 x H 1183 x P 559 W 448 x H 1183 x D 559 | D971 | 131 | 20 | 0,070 |
| | | | | | | |
|  | Tubo appendiabiti in alluminio Aluminium hanging rail | L 862 per vano da L 875 mm W 862 for W 875 mm compartment | T081 | 6 | 1,5 | 0,003 |
| | | L 1311 per vano da L 1324 mm W 1311 for W 1324 mm compartment | T131 | 6 | 2 | 0,004 |
|  | Appendiabiti estraibile in acciaio cromato Chromed steel pull out clothes rail | L 50 x H 60 x P 320/490 mm W 50 x H 60 x D 320/490 mm | PC06 | 23 | 2 | 0,001 |
| | | | | | | |

Non si esegue nessun tipo di lavorazione fuori misura
No custom-sizing is available

ACCESSORI PER MODULI / ACCESSORIES FOR MODULES

| Disegno Drawing | Descrizione Description | Misure Dimensions | Codice Code | Prezzo | Kg. | m ³ |
|---|---|---|----------------|------------|------|----------------|
| | | | | Price | | |
|  | Faretto ad incasso su coperchio con sensore a LED L 300 x L 100 x H 6 mm (finitura bianca) 5 watt / 12v completo di trasformatore Attenzione! Foro per il sensore a cura del cliente Recessed LED spotlight on top panel, with sensor W 300 x W 100 x H 6 mm (white finish) 5 Watt / 12V with transformer Important! It is up to the customer to make a hole to accommodate the sensor | | LA04 | 170 | 0,50 | 0,001 |
| | | | | | | |
|  | Specchio interno completo di ferramenta per fissaggio Interior mirror provided with fixings | L 370 x H 1600 W 370 x H 1600 | SI02 | 51 | 7 | 0,035 |
| | | | | | | |
|  | Meccanismo di apertura rallentata (per anta scorrevole) Soft opening mechanism for sliding doors | | KIT7 | 42 | 0,01 | 0,001 |
| | | | | | | |
| | | | CER20 | 9 | - | - |
|  | Cerniera compresa di basetta per armadi battenti apertura 90° Chiusura rallentata Hinge with base plate for 90° hinged door wardrobes Soft closing | | | | | |
| | | | | | | |
|  | Cerniera compresa di basetta per armadi battenti apertura 90° Hinge with base plate for 90° hinged door wardrobes | | CER21 | 9 | - | - |
| | | | | | | |

Non si esegue nessun tipo di lavorazione fuori misura
No custom-sizing is available

INFO TECNICHE

LETTERE

LETTI

QUBO – MAYA – DORY - SMILE

Testiera: Telaio strutturale realizzato con pannelli in particelle di legno grezzo classe E1 sp.80 mm, imbottita con materiale espanso e rivestita in ecopelle.

Giroletto: Realizzato con pannelli in particelle di legno grezzo classe E1 sp. 25 mm, imbottito con materiale espanso e rivestito in ecopelle. Fornito con piedi in legno laccati bianco opaco.

SKY

Testiera: Realizzata con pannelli in particelle di legno classe E1 sp. 30 mm nobilitati in melaminico.

Giroletto: Realizzato con pannelli MDF sp. 30 mm nobilitati in melaminico. Fornito con staffe e piedi in metallo colore grigio.

SPARK

Testiera: Realizzata con pannelli in particelle di legno classe E1 di sp. 22 mm nobilitati in melaminico.

Giroletto: Realizzato con pannelli MDF sp. 30 mm nobilitati in melaminico. Fornito con staffe e piedi in metallo colore grigio.

VIKI

Testiera: Realizzata con pannelli in particelle di legno classe E1 sp. 31/73 mm nobilitati in melaminico.

Giroletto: Realizzato con pannelli MDF sp. 30 mm nobilitati in melaminico. Fornito con staffe e piedi in metallo colore grigio.

KIT ALZALETTO (1 POSIZIONE)

Struttura: Formato da una coppia di piastre in metallo munite di fori e aste di sollevamento, più 2 piastre angolari forate per il fissaggio alla rete. Per facilitare l'alzata il meccanismo è fornito di pistoni pneumatici a gas. Per il corretto funzionamento si consiglia di utilizzare un materasso di max. 45 Kg.

PANNELLO FONDO CONTENITORE

Realizzato con pannelli in particelle di legno classe E1 nobilitati in melaminico colore bianco, comprensivo di traversa per il sostegno.

CUSCINI PER LETTO SKY – SPARK

Realizzati in poliuretano espanso con falda acrilica, rivestiti in ecopelle.

ARMADI

GRUPPI

BETA

Struttura: Realizzata con pannelli in particelle di legno classe E1 di sp. 18 mm nobilitati in melaminico.

Frontali cassetto: Realizzati con pannelli in particelle di legno classe E1 di sp. 22 mm nobilitati in melaminico.

Spondine cassetto: Realizzate con pannelli in particelle di legno classe E1 sp. 12 mm avvolte in PVC finitura tessuto grigio goffrato.

Fondo cassetto: Realizzato con pannelli in MDF sp. 4 mm, stampato in finitura tessuto grigio.

Guide cassetto: Guida a scomparsa con estrazione parziale, self closing e chiusura rallentata.

Piedini: in materiale plastico colore alluminio H 20 mm, montati sulla struttura (fondo).

WAY

Struttura: Realizzata con pannelli in particelle di legno classe E1 di sp. 18 mm nobilitati in melaminico.

Frontali cassetto: Realizzati con pannelli in particelle di legno classe E1 di sp. 22 mm nobilitati in melaminico.

Spondine cassetto: Realizzate con pannelli in particelle di legno classe E1 sp. 12 mm avvolte in PVC finitura tessuto grigio goffrato.

Fondo cassetto: Realizzato con pannelli in MDF sp. 4 mm, stampato in finitura tessuto grigio.

Guide cassetto: Guida a scomparsa con estrazione parziale, self closing e chiusura rallentata.

Piedini: Distanziali in materiale plastico montati sullo spessore dei fianchi.

GLISS

Struttura: Realizzata con pannelli in particelle di legno classe E1 di sp. 22 mm nobilitati in melaminico.

Frontali cassetto: Realizzati con pannelli in MDF curvati sp. 18 mm nobilitati in melaminico.

Spondine cassetto: Realizzate con pannelli in particelle di legno classe E1 sp. 12 mm avvolte in PVC finitura tessuto grigio goffrato.

Fondo cassetto: Realizzato con pannelli in MDF sp. 4 mm, stampato in finitura tessuto grigio.

Guide cassetto: Guida a scomparsa con estrazione parziale, self closing e chiusura rallentata.

Piedini: in materiale plastico colore grigio H 15 mm, montati sulla struttura (fondo).

listino prezzi 2018

ARMADI

SPECCHIERE WAY – HOME

Realizzate con pannelli in particelle di legno classe E1 sp. 18 mm nobilitati in melaminico, con specchio sp. 3 mm, complete di ferramenta per il fissaggio a parete.

SPECCHIERE OVALE – JOY

Realizzate con pannelli in particelle di legno classe E1 sp. 18 mm nobilitati in melaminico, con specchio sp. 4 mm bisellato complete di ferramenta per il fissaggio a parete.

ARMADI

ANTA DOOR

Anta realizzata con pannelli in particelle di legno in classe E1 sp. 22 mm. Nobilitata in melaminico nelle finiture: Olmo artico, Ghiaccio. Dotata di 4 cerniere rallentate in chiusura per ogni singola anta. Maniglia di serie art. A320 in finitura alluminio.

ANTA GOLA

Anta realizzata con pannelli in particelle di legno in classe E1 sp. 22 mm. Nobilitata in melaminico nelle finiture: Olmo artico, Ghiaccio. Dotata di 4 cerniere rallentate in chiusura per ogni singola anta. Profilo maniglia a gola in alluminio integrato sullo spessore del pannello, laccato opaco Bianco o Ghiaccio.

ANTA BASIC

Anta realizzata con pannelli in particelle di legno in classe E1 sp. 18 mm. Nobilitata in melaminico nelle finiture: Olmo artico Ghiaccio, rallentata in chiusura. Profilo Maniglia in alluminio laccato opaco Bianco o Ghiaccio.

ANTA ARCO

Anta realizzata con pannelli in particelle di legno in classe E1 sp. 18 mm, con specchio incollato sp.4 mm. Nobilitata in melaminico nelle finiture: Olmo artico Ghiaccio, rallentata in chiusura. Profilo Maniglia in alluminio laccato opaco Bianco o Ghiaccio.

FIANCHI / DIVISIONI

Realizzati con pannelli in particelle di legno in classe E1 sp. 22 mm. Divisioni nobilitati in melaminico Ghiaccio.

Fianchi nobilitati in melaminico olmo artico o Ghiaccio.

ARMADIO BATTENTE:

Dotazione di serie per ogni vano:

1 fondo sp. 22 mm in finitura melaminico ghiaccio
1 coperchio sp. 22 mm in finitura melaminico ghiaccio
1 ripiano sp. 30 mm in finitura melaminico ghiaccio
2 tubi appendiabiti in finitura alluminio
1 schiena sp. 5 mm in finitura melaminico ghiaccio
1 battuta parapolvere
Chiusura rallentata (su ogni singola anta)

ARMADIO SCORREVOLE:

Dotazione di serie per ogni vano:

1 fondo sp. 22 mm in finitura melaminico ghiaccio
1 coperchio sp. 22 mm in finitura melaminico ghiaccio
1 ripiano sp. 30 mm in finitura melaminico ghiaccio
2 tubi appendiabiti in finitura alluminio
1 schiena sp. 5 mm in finitura melaminico ghiaccio
1 binario
Chiusura rallentata (su ogni singola anta)

CASSETTIERA INTERNA

Struttura: Realizzata con pannelli in particelle di legno classe E1 di sp. 22 mm nobilitati in melaminico ghiaccio.

Frontali cassetto: Realizzati con pannelli n particelle di legno classe E1 sp. 22 mm nobilitati in melaminico ghiaccio.

Spondine cassetto: Realizzate con pannelli in particelle di legno classe E1 sp. 12 mm avvolte in PVC finitura tessuto grigio goffrato.

Fondo cassetto: Realizzato con pannelli in MDF sp. 4 mm, stampato in finitura tessuto grigio.

Guide cassetto: Guida a scomparsa con estrazione parziale, self closing e chiusura rallentata.

DIVISORIO CON RIPIANI

Realizzati con pannelli in particelle di legno classe E1 di sp. 22 mm nobilitati in melaminico ghiaccio.

RIPIANI

Realizzati con pannelli in particelle di legno classe E1 di sp. 30 mm nobilitati in melaminico ghiaccio.

technical information

TECHNICAL INFORMATION

BEDS

QUBO – MAYA – DORY - SMILE

Headboard: Structural frame made from 80 mm thick, class E1 bare wood particleboard upholstered with foamed material and covered with eco-leather.

Bed frame: Made from 25 mm thick, class E1, bare wood particleboard upholstered with foamed material and covered with eco-leather. Supplied with matt white lacquered wooden feet.

SKY

Headboard: Made from 30 mm thick, class E1, melamine-faced wood particleboard.

Bed frame: Made from 30 mm thick melamine-faced MDF. Supplied with grey-coloured metal brackets and feet.

SPARK

Headboard: Made from 22 mm thick, class E1, melamine-faced wood particleboard.

Bed frame: Made from 30 mm thick melamine-faced MDF. Supplied with grey-coloured metal brackets and feet.

VIKI

Headboard: Made from 31/73 mm thick, class E1, melamine-faced wood particleboard.

Bed frame: Made from 30 mm thick melamine-faced MDF. Supplied with grey-coloured metal brackets and feet.

1-POSITION LIFT-UP MECHANISM

Structure: Made out of a pair of bored metal plates provided with lift-up rods plus 2 bored corner plates to fix the bed base. To ease the lift-up motion the mechanism is supplied with pneumatic gas pistons. To ensure proper operation it is advisable to use a mattress weighing maximum 45 kg.

STORAGE BASE BOTTOM PANEL

Made from class E1, white-coloured melamine-faced wood particleboard, including a supporting beam.

CUSHIONS FOR THE SKY – SPARK BED

Made from polyurethane foam with acrylic wadding, covered with eco-leather.

ARMADI

BEDROOM FURNITURE

BETA

Carcass: Made from 18 mm thick, class E1, melamine-faced wood particleboard.

Drawer fronts: Made from 22 mm thick, class E1, melamine-faced wood particleboard.

Drawer sides: Made from 12 mm thick, class E1 wood particleboard wrapped with grey, fabric-effect, embossed PVC.

Drawer bottom panel: Made from 4 mm thick MDF, printed with a grey, fabric-effect finish.

Drawer runners: Partial-extension, hide-away, soft-close runners.

Feet: H 20 mm, in aluminium-coloured plastic mounted on the bottom panel.

WAY

Carcass: Made from 18 mm thick, class E1, melamine-faced wood particleboard.

Drawer fronts: Made from 22 mm thick, class E1, melamine-faced wood particleboard.

Drawer sides: Made from 12 mm thick, class E1 wood particleboard wrapped with grey, fabric-effect, embossed PVC.

Drawer bottom panel: Made from 4 mm thick MDF, printed with a grey, fabric-effect finish.

Drawer runners: Partial-extension, hide-away, soft-close runners.

Feet: Plastic spacers mounted on the bottom edge of the side panels.

GLISS

Carcass: Made from 22 mm thick, class E1, melamine-faced wood particleboard.

Drawer fronts: Made from curved, 18 mm thick, melamine-faced MDF.

Drawer sides: Made from 12 mm thick, class E1 wood particleboard wrapped with grey, fabric-effect, embossed PVC.

Drawer bottom panel: Made from 4 mm thick MDF, printed with a grey, fabric-effect finish.

Drawer runners: Partial-extension, hide-away, soft-close runners.

Feet: H 15 mm, in grey-coloured plastic mounted on the bottom panel.

WAY – HOME MIRRORS

Made from 18 mm thick, class E1, melamine-faced wood particleboard with a 3 mm thick mirror, provided with wall-mount fixings.

OVALE – JOY MIRRORS

Made from 18 mm thick, class E1, melamine-faced wood particleboard with a 4 mm thick bevelled mirror, provided with wall-mount fixings.

technical information

TECHNICAL INFORMATION

WARDROBES

“DOOR” DOOR

Door made from 22 mm thick, class E1 wood particleboard. Faced with melamine in the following finishes: Olmo Artico, Ghiaccio. Provided with 4 soft-close hinges for each door. Standard, aluminium-finish handle item A320.

GOLA DOOR

Door made from 22 mm thick, class E1 wood particleboard. Faced with melamine in the following finishes: Olmo Artico, Ghiaccio. Provided with 4 soft-close hinges for each door.

Matt Bianco or Ghiaccio lacquered aluminium grip channel built into the door panel.

BASIC DOOR

Door made from 18 mm thick, class E1 wood particleboard. Faced with melamine in the following finishes: Olmo Artico, Ghiaccio, with soft-close mechanism.

Matt Bianco or Ghiaccio lacquered aluminium grip edging.

ARCO DOOR

Door made from 18 mm thick, class E1 wood particleboard to which a 4 mm thick mirror is attached with glue. Faced with melamine in the following finishes: Olmo Artico, Ghiaccio, with soft-close mechanism. Matt Bianco or Ghiaccio lacquered aluminium grip edging.

ARMADI

SIDE PANELS / PARTITIONS

Door made from 22 mm thick, class E1 wood particleboard. Partitions faced with Ghiaccio-coloured melamine.

Side panels faced with Olmo Artico or Ghiaccio-coloured melamine.

HINGED DOOR WARDROBE:

Standard accessories for each compartment:
1 × 22 mm thick bottom panel faced with Ghiaccio-coloured melamine
1 × 22 mm thick top panel faced with Ghiaccio-coloured melamine
1 × 30 mm thick shelf faced with Ghiaccio-coloured melamine
2 aluminium-finish hanging rails
1 × 5 mm thick back panel faced with Ghiaccio-coloured melamine
1 door jamb dust seal
Soft-close mechanism (for each single door).

SLIDING DOOR WARDROBE:

Standard accessories for each compartment:
1 × 22 mm thick bottom panel faced with Ghiaccio-coloured melamine
1 × 22 mm thick top panel faced with Ghiaccio-coloured melamine
1 × 30 mm thick shelf faced with Ghiaccio-coloured melamine
2 aluminium-finish hanging rails
1 × 5 mm thick back panel faced with Ghiaccio-coloured melamine
1 track
Soft-close mechanism (for each single door).

INTERIOR DRAWER UNIT:

Carcass: Made from 22 mm thick, class E1, Ghiaccio-coloured melamine-faced wood particleboard.

Drawer fronts: Made from 22 mm thick, class E1, Ghiaccio-coloured melamine-faced wood particleboard.

Drawer sides: Made from 12 mm thick, class E1 wood particleboard wrapped with grey, fabric-effect, embossed PVC.

Drawer bottom panel: Made from 4 mm thick MDF, printed with a grey, fabric-effect finish.

Drawer runners: Partial-extension, hide-away, soft-close runners.

ARMADI

SIDE PANELS / PARTITIONS

Door made from 22 mm thick, class E1, Ghiaccio-coloured melamine-faced wood particleboard.

PARTITION WITH SHELVES:

Made from 22 mm thick, class E1, Ghiaccio-coloured melamine-faced wood particleboard.

SHELVES:

Made from 30 mm thick, class E1, Ghiaccio-coloured melamine-faced wood particleboard.

CONDIZIONI GENERALI DI VENDITA

Le seguenti condizioni di vendita sono integralmente accettate dall'acquirente con il conferimento dell'ordine.

1. **Accettazione:** ogni ordine è assunto "con riserva d'accettazione da parte della Casa".
2. **Prezzi:** la fornitura avviene sempre al prezzo indicato nei listini della Casa ed alle condizioni in vigore alla data della conferma d'ordine.
3. **Consegna:** la fornitura accade con la massima sollecitudine, subordinatamente alle disponibilità di magazzino ed alle possibilità di produzione ed inoltre eventuali termini di consegna inseriti nella conferma d'ordine hanno valore semplicemente indicativo e non tassativo. I termini di consegna rimangono in ogni caso sospesi per caso fortuito e per forza maggiore.
4. **Trasporto:** tutte le merci spedite a mezzo terzi ed anche se rese franco destino, viaggiano a rischio e pericolo dell'acquirente.
5. **Reclami:** eventuali difformità tra fornitura e conferma d'ordine, come eventuali difetti o vizi dei prodotti forniti, devono essere segnalati per iscritto alla Casa immediatamente dopo il ricevimento della fornitura ed in ogni caso entro quattro giorni da esso.
6. **Sostituzioni:** la merce eventualmente riconosciuta difettosa e sostituita dalla fornitrice, deve essere resa immediatamente all'atto del rimpiazzo. In questi caso la responsabilità della Casa produttrice sarà limitata alla sola sostituzione delle parti avariate, escludendo alcun aggravio di spese di trasporto, montaggio o d'altro genere. La mancata restituzione della merce entro 30 gg. dall'avvenuta sostituzione, autorizzerà la fornitrice alla fatturazione della stessa al prezzo dei listini in vigore ed alla riscossione del pagamento.
7. **Pagamenti:** modalità di pagamento e relativi termini, sono precisati nella conferma d'ordine, l'eventuale accettazione di titoli di credito da parte della Casa avviene sempre salvo buon fine, senza novazione del rapporto sottostante e senza modifiche del Foro competente.
8. **Cautele:** la Casa ha facoltà di sospendere le forniture, quando le condizioni economiche dell'acquirente fossero tali da porre in evidente pericolo il conseguimento del pagamento; nel caso di pagamenti differiti; la mancata puntuale osservanza delle scadenze stabilite, legittima la Casa a richiedere il versamento immediato dell'intero residuo prezzo.
9. **Deroghe:** le condizioni generali operano in ogni caso, ove non siano derogate espressamente e per atto scritto dalla Casa.
10. **Modifiche:** la Casa si riserva di apportare in ogni momento tutte le modifiche alla modellistica che terrà opportune senza preavviso alcuno.
11. **Foro:** il luogo d'adempimento delle obbligazioni gravanti sull'acquirente s'identifica con la sede legale del Foro di Pordenone. Tutte le eventuali controversie aventi origine dalle forniture, saranno attribuite alla competenza esclusiva del Tribunale di Pordenone.
12. **Proprietà:** la merce rimane di proprietà della ditta venditrice fino a completo pagamento della stessa; se il pagamento è dilazionato, fino al buon fine dell'ultima scadenza. Solo dopo il regolamento completo la merce passerà di proprietà dell'acquirente. Quest'ultimo non ha diritto di vendere, di impegnare, di assicurare l'offerta o di cedere in qualsiasi altro modo a terza persona la merce prima di questo termine. In caso di mancato o ritardato pagamento, la Casa venditrice si riserva la facoltà di riprendersi la merce.
13. **Fuori serie:** non realizzabili
14. **Forme di pagamento:** le forme di pagamento, uniche ed inderogabili, sono quelle riportate sulle nostre circolari in merito e sui nostri blocchi di commissione. Non saranno prese in considerazione altre forme.

Ai prezzi riportati nel presente listino deve essere aggiunta l'I.V.A. in vigore.

GENERAL TERMS OF SALE

The purchaser on confirmation of the order wholly accepts the following terms of sale.

1. **Acceptance:** every order is taken "with reserve of acceptance by the Company".
2. **Prices:** the supply is always made at the prices shown in the Company's pricelists and under the terms in force at the confirmation's date.
3. **Delivery:** the goods are supplied with the maximum diligence, subject to warehouse availability and production possibilities; in addition, any delivery dates in the confirmation of order have a purely indicative value and are in no way binding. The terms of delivery remain pending in exceptional circumstances and in cases of force major.
4. **Transport:** all goods dispatched by third parties, and even if they are delivered free of carriage, travel at the purchaser's risk.
5. **Complaints:** any differences between the supply and the confirmation of order, or any defects or faults of the goods supplied, must be notified in writing to the Company immediately after receipt of the goods and, in any case, within four days of this date.
6. **Replacements:** any goods recognized as faulty and replaced by the manufacturer must be immediately returned when replaced. In these cases, the responsibility of the manufacturing company shall be limited only to the replacement of the faulty parts, excluding any increase in transport, assembly or any other kind of charges. Failure to return the goods within 30 days of replacement will oblige the supplier to invoice the goods at the current price list.
7. **Payments:** methods of payment and relative conditions are specified in the offer. Any acceptance of instruments of credit by the Company is always subject to collection, without novation of the basic relationship and without amendments to the competent Court of Law.
8. **Precautions:** the Company has the faculty of suspending supply should the economic conditions of the purchaser appear to be such as to place payment in clear danger, in the event of deferred payments, failure to observe punctually the established due dates justifies the Company to request immediate payment of the total balance of the price.
9. **Exceptions:** the general terms operate in all cases where the Company has specified no exceptions in writing.
10. **Modifications:** the Company reserves the right to make any modifications to the design of models it deems necessary without any notice.
11. **Court of Law:** the place of fulfilment of the obligations weighing on the purchaser is the Court of Law of PORDENONE. Any disputes having their origin in the supply shall be assigned to the exclusive competence of the Law Courts of PORDENONE.
12. **Ownership:** the goods remain the property of the seller until payment of the goods has been completed. If the payment is extended, the goods remain the property of the seller until collection of the last instalment. The goods will become the property of the purchaser only after complete settlement. The latter does not have the right to sell, pledge, insure the offer or transfer the goods in any other way to a third party prior to this term. In the event of failure to pay delay payment, the seller reserves the faculty to take back the goods.
13. **Made-to-order:** unfeasible
14. **Forms of payment:** cash or letter of credit at sight.

The prices shown in this pricelist are in Euro and net of V.A.T.

